

	100 V~ - 240 V~
	50 / 60 Hz
	8 mm    2 x 2,5 mm <sup>2</sup>
	-5°C / +45°C
	PIR
	150 lux
	15 min.
	Ø 5 m
	15 m

230 V~	2000 W	8,5 A	1000 VA	4,3 A	1000 VA	4,3 A	10x(2x36 W)	4,3 A
110 V~	1000 W		500 VA		500 VA		5x(2x36 W)	

230 V~	250 W	1 A	250 W	1 A	250 W	1 A	500 VA	2,1 A
110 V~	125 W		125 W		125 W		250 VA	

230 V~	500 VA	2,1 A max.	I max. ≤ 2,1A
110 V~	250 VA		
U ≤ 30 V=	2,1 A max.		

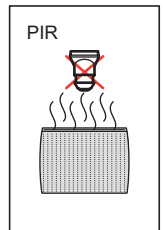
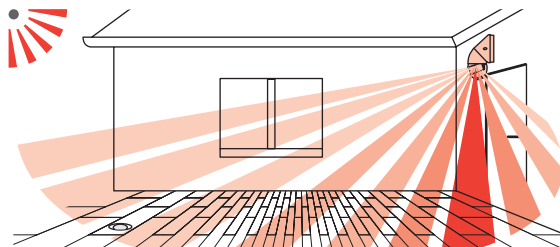
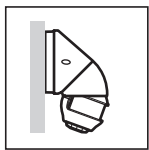
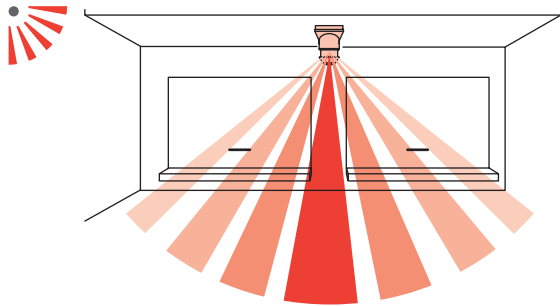
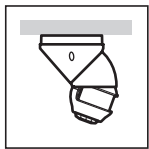
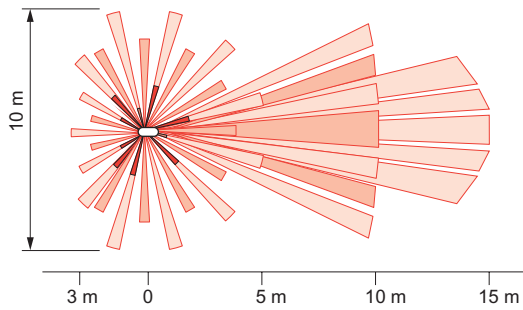
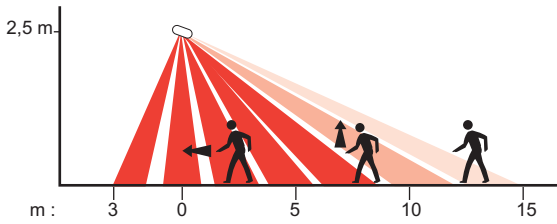
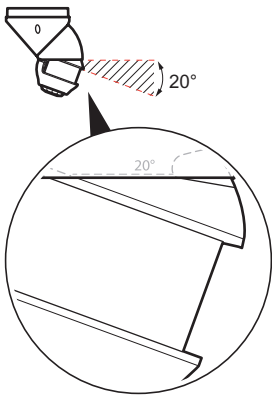

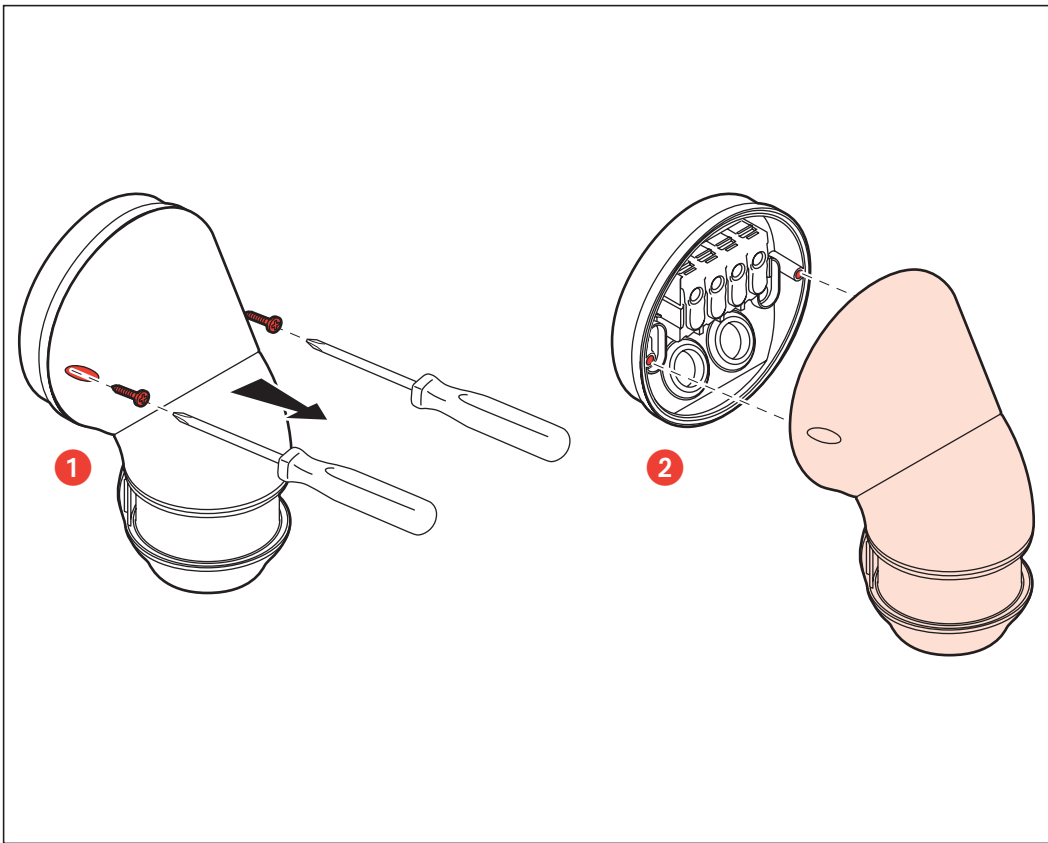
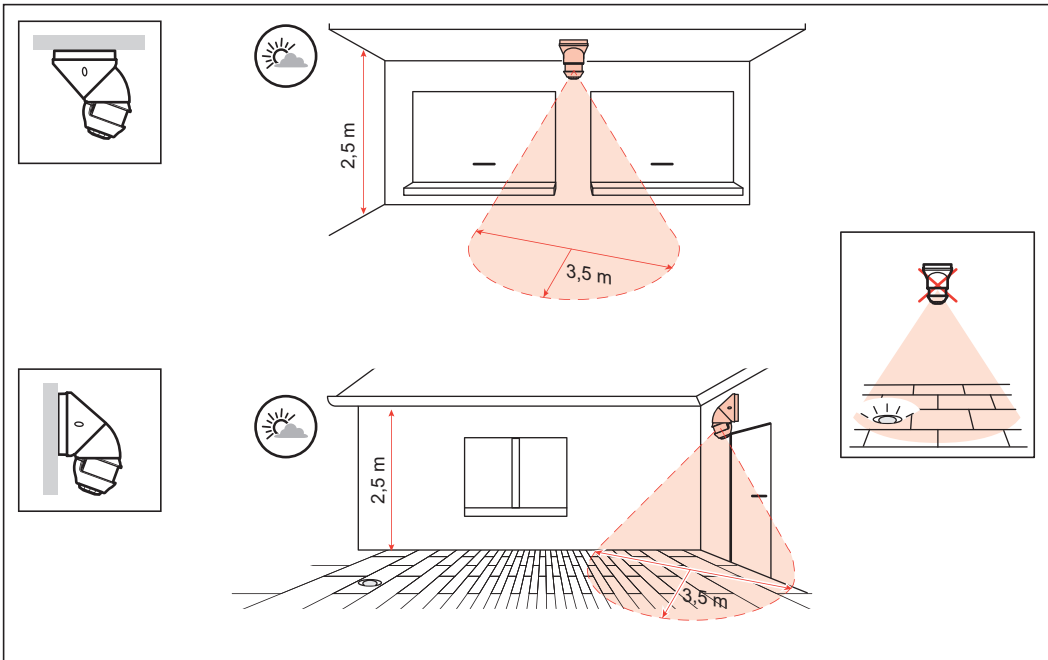

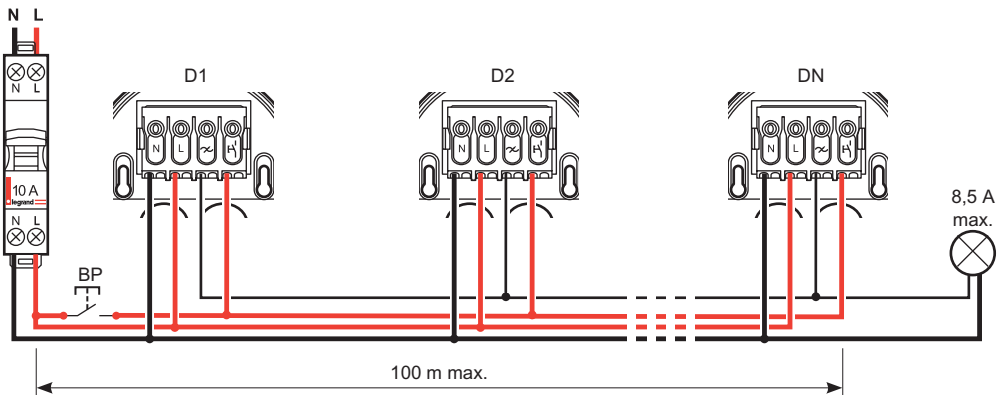
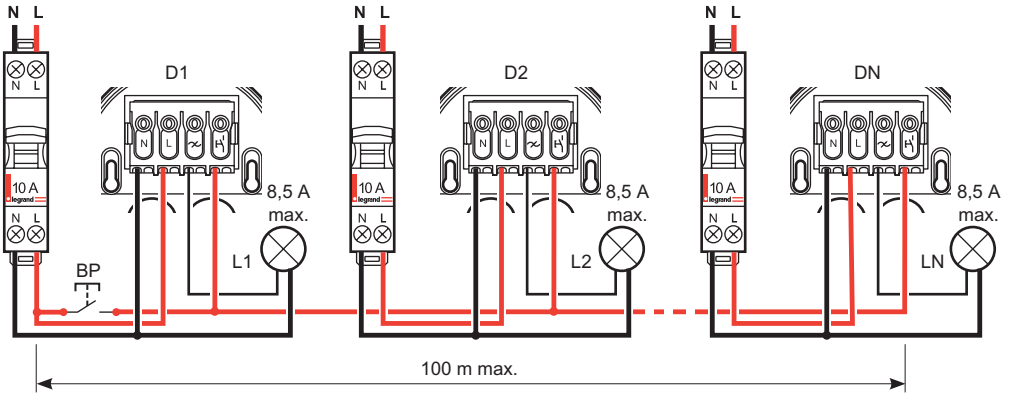
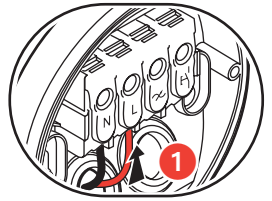
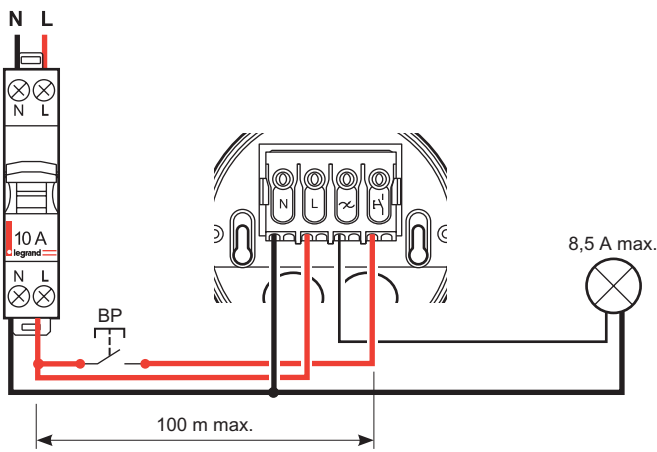

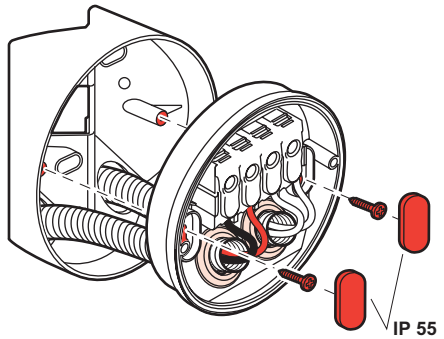
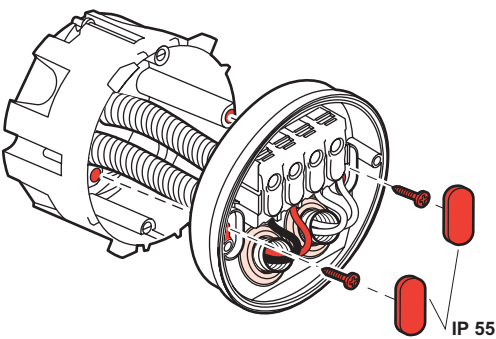
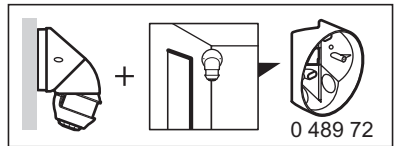
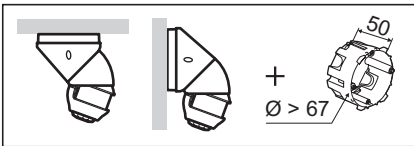
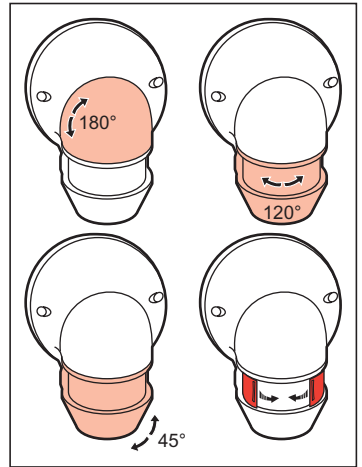
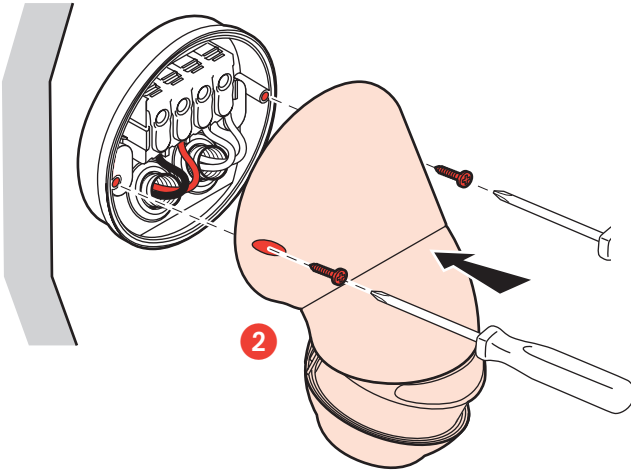
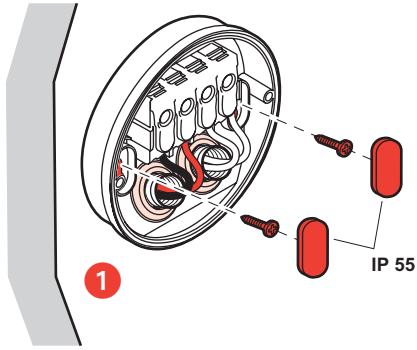
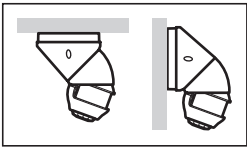



**Auto ON/OFF**

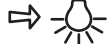
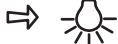
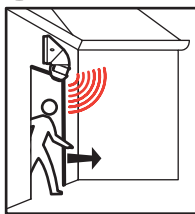

**Manual ON / Auto OFF**

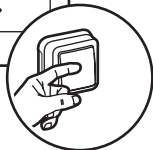
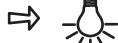

[www.legrandoc.com](http://www.legrandoc.com)

	5 - 1275 lux
	5 sec - 59 min 59 sec
	25% - 50% - 75% - 100%
Mode	Auto - Manual - Walkthrough



0 882 30



0 882 35

